



# GreenSpace G5

## DN392B LED16/840 PSD D150 ALU GM

Power supply unit with DALI interface - High-gloss high reflectance - Transparent bowl with white cover - 65° -

GreenSpace Gen5 is a new LED downlight range combining light efficiency and comfort with product diversity and system compatibility

### Product data

General information	
Beam angle of light source	60°
Light source color	840 neutral white
Light source replaceable	No
Number of gear units	1 unit
Driver/power unit/transformer	Power supply unit with DALI interface
Driver included	Yes
Optic type	High-gloss high reflectance
Optical cover/lens type	Transparent bowl with white cover
Luminaire light beam spread	65°
Control interface	DALI
Protection class IEC	Safety class I
Glow-wire test	Temperature 650 °C, duration 30 s
Flammability mark	For mounting on normally flammable surfaces
CE mark	CE mark
Warranty period	3 years
Constant light output	No
Number of products on MCB of 16 A type B	24
Light source engine type	LED

Operating and electrical	
Input Voltage	220-240 V
Input Frequency	50 or 60 Hz
Inrush current	20.4 A
Inrush time	0.195 ms
Power Factor (Min)	0.95
Controls and dimming	
Dimmable	Yes
Mechanical and housing	
Housing Material	Aluminum die cast
Reflector material	Polycarbonate aluminum coated
Optic material	Polycarbonate
Optical cover/lens material	Polycarbonate
Optical cover/lens finish	Matte
Overall length	0 mm
Overall width	0 mm
Overall height	100 mm
Overall diameter	162 mm

# GreenSpace G5

Color	Black and white
-------	-----------------

## Approval and application

Ingress protection code	IP20 [ Finger-protected]
Mech. impact protection code	IK02 [ 0.2 J standard]

## Initial performance (IEC compliant)

Initial luminous flux (system flux)	1600 lm
Luminous flux tolerance	+/-10%
Initial LED luminaire efficacy	110 lm/W
Init. Corr. Color Temperature	4000 K
Init. Color Rendering Index	>80
Initial chromaticity	(0.38,0.38) SDCM<5
Initial input power	15.5 W
Power consumption tolerance	+/-10%

## Over time performance (IEC compliant)

Median useful life L70B50	50000 h
---------------------------	---------

Median useful life L80B50	43000 h
Median useful life L90B50	20000 h

## Application conditions

Ambient temperature range	-20 to +40 °C
---------------------------	---------------

## Product data

Full product code	911401585741
Order product name	DN392B LED16/840 PSD D150 ALU GM
Order code	911401585741
Numerator - Quantity Per Pack	1
Numerator - Packs per outer box	1
Material Nr. (12NC)	911401585741
Copy Net Weight (Piece)	0.600 kg



## Dimensional drawing

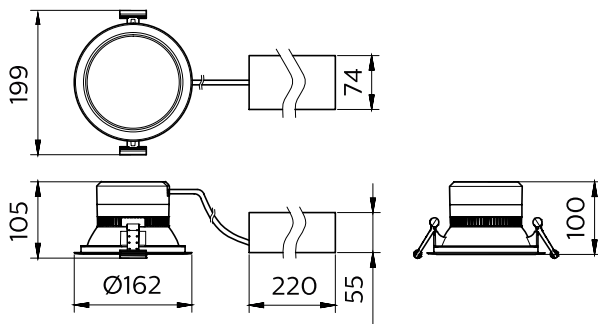

DN392B LED16/840 PSD D150 ALU GM

