



GreenSpace G5

DN392B LED16/840 PSD D200 WH GM

Power supply unit with DALI interface - High-gloss high reflectance - Transparent bowl with white cover - 80° -

GreenSpace Gen5 is a new LED downlight range combining light efficiency and comfort with product diversity and system compatibility

Product data

General information	
Beam angle of light source	92°
Light source color	840 neutral white
Light source replaceable	No
Number of gear units	1 unit
Driver/power unit/transformer	Power supply unit with DALI interface
Driver included	Yes
Optic type	High-gloss high reflectance
Optical cover/lens type	Transparent bowl with white cover
Luminaire light beam spread	80°
Control interface	DALI
Protection class IEC	Safety class I
Glow-wire test	Temperature 650 °C, duration 30 s
Flammability mark	For mounting on normally flammable surfaces
CE mark	CE mark
Warranty period	3 years
Constant light output	No
Number of products on MCB of 16 A type B	24
Light source engine type	LED

Operating and electrical	
Input Voltage	220-240 V
Input Frequency	50 or 60 Hz
Inrush current	20.4 A
Inrush time	0.195 ms
Power Factor (Min)	0.95
Controls and dimming	
Dimmable	Yes
Mechanical and housing	
Housing Material	Aluminum die cast
Reflector material	Polycarbonate
Optic material	Polycarbonate
Optical cover/lens material	Polycarbonate
Optical cover/lens finish	Matte
Overall length	0 mm
Overall width	0 mm
Overall height	108 mm
Overall diameter	216 mm

GreenSpace G5

Color	Black and white
-------	-----------------

Approval and application

Ingress protection code	IP20 [Finger-protected]
Mech. impact protection code	IK02 [0.2 J standard]

Initial performance (IEC compliant)

Initial luminous flux (system flux)	1600 lm
Luminous flux tolerance	+/-10%
Initial LED luminaire efficacy	110 lm/W
Init. Corr. Color Temperature	4000 K
Init. Color Rendering Index	>80
Initial chromaticity	(0.38,0.38) SDCM<5
Initial input power	15.5 W
Power consumption tolerance	+/-10%

Over time performance (IEC compliant)

Median useful life L70B50	50000 h
---------------------------	---------

Median useful life L80B50	43000 h
Median useful life L90B50	20000 h

Application conditions

Ambient temperature range	-20 to +40 °C
---------------------------	---------------

Product data

Full product code	911401582141
Order product name	DN392B LED16/840 PSD D200 WH GM
Order code	911401582141
Numerator - Quantity Per Pack	1
Numerator - Packs per outer box	1
Material Nr. (12NC)	911401582141
Copy Net Weight (Piece)	0.680 kg



Dimensional drawing

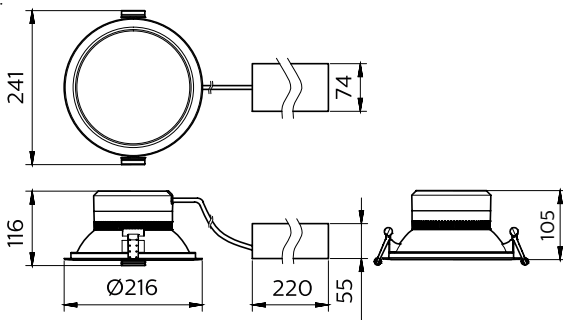

DN392B LED16/840 PSD D200 WH GM

