



GreenPerform Panel

SP160P LED40S 840 W60L60 PSU

Wide beam - Polystyrene bowl/cover prismatic - 110° -

GreenPerform Panel is the slimmest Panel with highest efficacy in the market. It offers two lumen options with four dimension types, 200X1200, 300X1200, 600x600,600x1200, and three mounting options, recessed, suspended and plaster ceiling.

Product data

General information	
Beam angle of light source	- °
Light source color	840 neutral white
Light source replaceable	No
Number of gear units	1 unit
Driver/power unit/transformer	-
Driver included	Yes
Optic type	Wide beam
Optical cover/lens type	Polystyrene bowl/cover prismatic
Luminaire light beam spread	110°
Control interface	-
Connection	Internal connector
Cable	-
Protection class IEC	Safety class II
Glow-wire test	Temperature 650 °C, duration 30 s
Flammability mark	-
CE mark	CE mark
ENEC mark	-
Warranty period	3 years
Constant light output	No

Number of products on MCB of 16 A type B	90
EU RoHS compliant	Yes
Light source engine type	LED
Service tag	Yes

Operating and electrical

Input Voltage	220 to 240 V
Input Frequency	50 to 60 Hz
Initial CLO power consumption	NA W
Average CLO power consumption	NA W
Inrush current	15.8 A
Inrush time	181 ms
Power Factor (Min)	0.9

Controls and dimming

Dimmable	No
----------	----

Mechanical and housing

Housing Material	Aluminum
Reflector material	-

GreenPerform Panel

Optic material	Polystyrene
Optical cover/lens material	Polystyrene
Fixation material	Steel
Optical cover/lens finish	Frosted
Overall length	595 mm
Overall width	595 mm
Overall height	11.5 mm
Color	White

Approval and application

Ingress protection code	IP20 [Finger-protected]
Mech. impact protection code	IK03 [0.3 J]

Initial performance (IEC compliant)

Initial luminous flux (system flux)	4000 lm
Luminous flux tolerance	+/-5%
Initial LED luminaire efficacy	110 lm/W
Init. Corr. Color Temperature	4000 K
Init. Color Rendering Index	>80

Initial chromaticity	(0.43, 0.40) SDCM<4
Initial input power	36 W
Power consumption tolerance	+/-10%

Application conditions

Ambient temperature range	-20 to +45 °C
Maximum dim level	Not applicable

Product data

Full product code	911401726922
Order product name	SP160P LED40S 840 W60L60 PSU
Order code	911401726922
Numerator - Quantity Per Pack	1
Numerator - Packs per outer box	2
Material Nr. (12NC)	911401726922
Copy Net Weight (Piece)	2.300 kg



Dimensional drawing

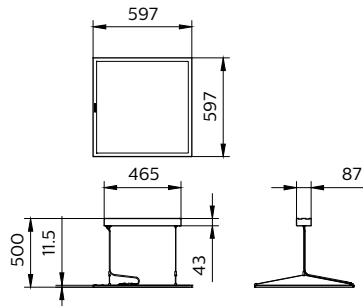

SP160P LED40S 840 W60L60 PSU

