



UV-C disinfection mini chamber

UVCC090 36W 12

2 pcs - 220 to 240 V - 50 or 60 Hz - Safety class I - Finger-protected - 0.2 J standard

Philips UV-C disinfection mini chamber (UVCC090) provides the perfect solution to disinfect small belongings, shared devices or objects touched by numerous people, such as a mouse, keyboard, headsets and remote controls. Simply place objects into the mini chamber then, set the timer for exposing the objects to UV-C light with the recommended disinfection scheme. The UV-C disinfection mini chamber can be (re)placed into many different areas, due to its light weight. With the design and its portable size you are providing a unique disinfecting solution to offer additional protection to your customers, guests and employees in multiple areas in hospitality, office and retail space. This UV-C disinfection chamber is not approved and/or certified as a medical device.

UV-C disinfection mini chamber

Warnings and Safety

• DANGER: Like any disinfection system, UV-C lamps and devices must be installed and used in the correct way. Direct exposure to UV-C can be dangerous and result in a sunburn-like reaction to the skin and serious damage to the cornea. UV-C disinfection mini chambers must only be sold through qualified partners and installed by professionals according to our stringent safety and legal requirements. Our UV-C products are not meant to be used in applications or activities which may cause and/or lead to death, personal injury and/or damage to the environment. **DISCLAIMER:** The UV-C disinfection mini chamber effectiveness in the inactivation of certain viruses, bacteria, protozoa, fungi or other harmful micro-organisms is as described above under the heading "Benefits". Signify and its group of companies do not promise or warrant that the use of the UV-C disinfection mini chamber will protect or prevent any user from infection and/or contamination with any viruses, bacteria, protozoa, fungi, illness or disease. The UV-C disinfection mini chamber is not approved for, is not intended for and must not be used to disinfect medical devices and must not be used in medical settings. In addition to and without limitation of any exclusions or limitations of liability of Signify and its group of companies as set forth in any agreement for the sale, distribution or otherwise making available of the UV-C disinfection mini chamber, Signify and its group of companies shall have no responsibility or liability whatsoever for any claim or damage that may arise from or relate to any use of the UV-C disinfection mini chamber outside of their intended use or contrary to their installation and operation instructions, each as described in this document under the heading "Application", the user manuals and/or the mounting instructions.

Product data

General Information	
Number of light sources	2 pcs
Beam angle of light source	- °
Number of gear units	1 unit
Gear	HF-S [HF Selectalume]
Optic type	-
Luminaire light beam spread	-
Control interface	-
Connection	Mains outlet socket
Cable	Cable 1.5 m with plug
Protection class IEC	Safety class I
Glow-wire test	Temperature 650 °C, duration 30 s
Flammability mark	-
CE mark	CE mark
ENEC mark	-
Warranty period	1 years
Number of products on MCB of 16 A type B	28
Photobiological risk	Photobiological risk group 0 @ 200mm to EN62471
EU RoHS compliant	Yes

Operating and Electrical

Input Voltage	220 to 240 V
Input Frequency	50 or 60 Hz
Inrush current	18 A
Inrush time	0.25 ms
Power Factor (Min)	0.9

Controls and Dimming

Dimmable	No
----------	----

Mechanical and Housing

Housing Material	Acrylonitrile butadiene styrene
------------------	---------------------------------

Reflector material	Steel
Optic material	-
Mounting device	-
Overall length	440 mm
Overall width	400 mm
Overall height	470 mm
Color	White RAL 9003

Approval and Application

Ingress protection code	IP20 [Finger-protected]
Mech. impact protection code	IK02 [0.2 J standard]

UV

UV-C radiation	6.1 W
UV-C irradiance defined at 20cm	400 µW/cm²

Initial Performance (IEC Compliant)

Initial input power	36 W
Power consumption tolerance	+/-10%

Application Conditions

Ambient temperature range	+10 to +40 °C
Performance ambient temperature Tq	25 °C
Maximum dim level	Not applicable
Suitable for random switching	No

Product Data

Full product code	871951452149000
Order product name	UVCC090 36W 12
EAN/UPC - Product	8719514521490
Order code	911401593971
Numerator - Quantity Per Pack	1
Numerator - Packs per outer box	1

UV-C disinfection mini chamber

Material Nr. (12NC)	911401593971
Net Weight (Piece)	9.400 kg

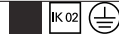

Dimensional drawing

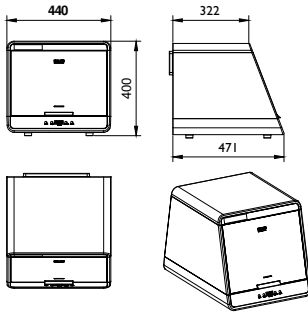

UVC Devices

