



GreenPerform Highbay G5

BY698X G5 LED150/NW L1 W WB GM L3m

Lens

The GreenPerform Highbay G5 continues the GreenPerform family's enviable reputation for reliable performance. Not only does it deliver leading system efficacy and extended long-term quality, it also promises Unified Glare Rating (UGR) control with compact dimensions. GreenPerform Highbay G5 is also fully compatible with IoT software such as Interact, which is a scalable, future-proof control system. The family also has a series that supports cold room applications with 100% humidity and no condensation. All benefits that make this robust, optimized, and versatile family suitable for almost all industrial applications.

Product data

General information		Controls and dimming	
Light source color	840 neutral white	Inrush current	40 A
Optical cover/lens type	Lens	Power Factor (Min)	0.95
Control interface	BLE	Mechanical and housing	
Protection class IEC	Safety class I	Housing Material	Aluminum Alloy
Flammability mark	For mounting on normally flammable surfaces	Optical cover/lens material	Polycarbonate
CE mark	CE mark	Optical cover/lens finish	Clear
Number of products on MCB of 16 A type B 6		Overall length	435 mm
Light source engine type	LED	Overall width	290 mm
Operating and electrical		Overall height	100 mm
Input Voltage	220 to 240 V		
Input Frequency	50 or 60 Hz		

GreenPerform Highbay G5

Color	Gray
Approval and application	
Ingress protection code	IP65 [Dust penetration-protected, jet-proof]
Mech. impact protection code	IK08 [6 J]
Initial performance (IEC compliant)	
Initial luminous flux (system flux)	15000 lm
Luminous flux tolerance	+/-10%
Initial LED luminaire efficacy	160 lm/W
Init. Corr. Color Temperature	4000 K
Init. Color Rendering Index	>80
Initial chromaticity	(0.385, 0.380) SDCM<5
Initial input power	95 W
Power consumption tolerance	+/-10%

Application conditions

Ambient temperature range	-30 to +50 °C
---------------------------	---------------

Product data

Full product code	871951495504200
Order product name	BY698X G5 LED150/NW L1 W WB GM L3m
EAN/UPC - Product	8719514955042
Order code	911401548202
Numerator - Quantity Per Pack	1
Numerator - Packs per outer box	1
Material Nr. (12NC)	911401548202
Net Weight (Piece)	2.290 kg

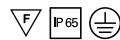

Dimensional drawing

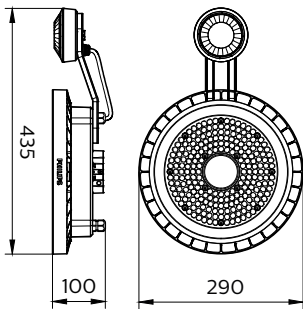

BY698X G5 LED150/NW L1 W WB GM L3m

