



ActiStar

BVP632 LED866/957 820W S6

ActiStar - 86600 lm - 820 W - 5700 K

Philips ActiStar Inherits and develops Philips brand floodlight consistent advantages to a new performance level to illuminate your recreational sports fields and areas with best-in-class LED technology. It's new ideal solution for a wide range of lighting applications, like recreational sports pitch, containers yard and ports, apron and industrial large areas, intersection road, etc. ActiStar will energize your sports facilities with uniformity and be able to enhance the safety of intersection roads by maximizing efficiencies. Optimized design for 1:1 retrofitting in compact size with lower weight, wide choice of optic, high manufacturing quality. It can deliver sufficient light at higher efficacy, and it incorporates best-in-class LED light source, modular optical system, heat sink and driver into one-piece housing that meets globally recognized safety standards. Its rigorous designed heat sink incorporates aesthetics and functionality to ensure excellent reliability. The superior lighting performance and longer lifetime to activate your and infinite potential, ActiStar.

Product data

General information	
Light source color	957 cool white
Driver included	No
Optical cover/lens type	Polycarbonate bowl/cover
Control interface	depends on driver (1-10V, DALI...)
Connection	Connection unit 5-pole
Cable	Cable 1.5 m with push-in connector 5-pole
Protection class IEC	Safety class I
Flammability mark	-
CE mark	CE mark

Operating and electrical	
Input Voltage	120 DC V
Input Frequency	- Hz
Power Factor (Min)	-
Controls and dimming	
Dimmable	No
Mechanical and housing	
Housing Material	Aluminum Alloy
Optical cover/lens material	Polycarbonate
Overall length	740 mm

Overall width	657 mm
Overall height	89 mm
Effective projected area	0.4 m ²
Color	Gray

Approval and application

Ingress protection code	IP66 [Dust penetration-protected, jet-proof]
Mech. impact protection code	IK08 [5 J vandal-protected]

Initial performance (IEC compliant)

Initial luminous flux (system flux)	86600 lm
Luminous flux tolerance	+/-10%
Initial LED luminaire efficacy	105.6 lm/W
Init. Corr. Color Temperature	5700 K
Init. Color Rendering Index	≥90
Initial chromaticity	0.3287, 0.3425

Initial input power	820 W
Power consumption tolerance	+/-10%

Application conditions

Ambient temperature range	-40 to +50 °C
---------------------------	---------------

Product data

Order product name	BVP632 LED866/957 820W S6
Order code	911401616508
Numerator - Quantity Per Pack	1
Numerator - Packs per outer box	1
Material Nr. (12NC)	911401616508
Net Weight (Piece)	24.390 kg

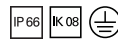

Dimensional drawing

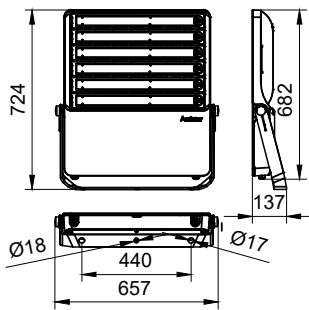

BVP632 LED866/957 820W S6

