



GreenSpace G6

DN391B LED11/840 P10PSD D100 WH GMG2

28, 10.2 W, White reflector and opal cover, Polycarbonate Diffuser, 78°

Philips GreenSpace G6 builds on the GreenSpace family's reputation for superb performance, extremely low energy use, and high visual comfort. This next generation of reliable LED downlights comes in a highly-compact design with a deep, recessed architecture and increased reflector depth to highlight the smallest of details. GreenSpace G6 is also a shining example of versatility. This energy-saving LED downlight is available in a comprehensive range of configurations from 600 to 3,550 lumen, with the option to choose fixed, dimmable, or Interact Ready variants. This makes GreenSpace G6 the perfect 'mix and match' solution for potentially broad and extended applications that require different lighting ambiances, with one cohesive luminaire look and feel.

Product data

General Information		Operating and Electrical	
Driver included	Yes	Light source color	840 neutral white
Gear	-	Optic type	White reflector and opal cover
Number of gear units	-	Optical cover/lens type	Polycarbonate Diffuser
Light source engine type	LED	Luminaire light beam spread	78°
Light Technical		Input Voltage	220 to 240 V
Luminous Flux	1,100 lumen	Line Frequency	50 or 60 Hz
Correlated Color Temperature (Nom)	4000 K	Input Frequency	50 or 60 Hz
Luminous Efficacy (rated) (Nom)	108 lm/W	Inrush current	5.5 A
Color rendering index (CRI)	≥80	Inrush time	0.055 ms
Number of light sources	28	Power Consumption	10.2 W
Beam angle of light source	- degree(s)	Power Factor (Fraction)	0.9

GreenSpace G6

Connection	2 Push-in connector 2-pole
Cable	-
Number of products on MCB of 16 A type B 54	
Temperature	
Ambient temperature range	-20 to +40 °C
Controls and Dimming	
Dimmable	DALI
Control interface	DALI
Mechanical and Housing	
Housing Material	Aluminum die-cast
Reflector material	Polycarbonate
Optic material	Polycarbonate
Optical cover/lens material	Polycarbonate
Housing Color	Black and white
Mounting device	Frame for recessed mounting
Optical cover/lens finish	Matte
Overall height	68 mm
Overall diameter	120 mm
Approval and Application	
Ingress protection code	IP20 [Finger-protected]
Mech. impact protection code	IK03 [0.3 J]
Protection class IEC	Safety class II
Glow-wire test	Temperature 650 °C, duration 5 s
Flammability mark	-
CE mark	CE mark

ENEC mark	-
Warranty period	3 years
Photobiological risk	Photobiological risk group 1 @200mm to EN62778
EU RoHS compliant	Yes

Initial Performance (IEC Compliant)

Luminous flux tolerance	+/-10%
Initial chromaticity	5
Power consumption tolerance	+/-10%

Application Conditions

Performance ambient temperature Tq	25 °C
Maximum dim level	1%
Suitable for random switching	No

Product Data

Order product name	DN391B LED11/840 P10PSD D100 WH GMG2
Order code	911401557332
Numerator - Quantity Per Pack	1
Numerator - Packs per outer box	4
Material number (12NC)	911401557332
Full product name	DN391B LED11/840 P10PSD D100 WH GMG2



Dimensional drawing

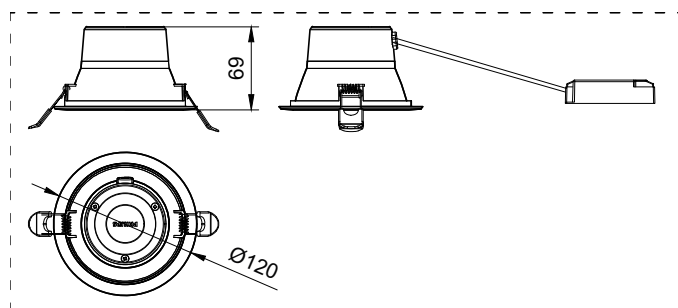

GreenSpace G6

