



GreenSpace G6

DN391B LED11/865 P10PSU D150 AL GMG2

24, 9.8 W, Facetted reflector, Polycarbonate Diffuser, 60°

Philips GreenSpace G6 builds on the GreenSpace family's reputation for superb performance, extremely low energy use, and high visual comfort. This next generation of reliable LED downlights comes in a highly-compact design with a deep, recessed architecture and increased reflector depth to highlight the smallest of details. GreenSpace G6 is also a shining example of versatility. This energy-saving LED downlight is available in a comprehensive range of configurations from 600 to 3,550 lumen, with the option to choose fixed, dimmable, or Interact Ready variants. This makes GreenSpace G6 the perfect 'mix and match' solution for potentially broad and extended applications that require different lighting ambiances, with one cohesive luminaire look and feel.

Product data

General Information		Optical cover/lens type	
Driver included	Yes	Optical cover/lens type	Polycarbonate Diffuser
Gear	-	Luminaire light beam spread	60°
Number of gear units	-	Operating and Electrical	
Light source engine type	LED	Input Voltage	220 to 240 V
Light Technical		Line Frequency	50 or 60 Hz
Luminous Flux	1,200 lumen	Input Frequency	50 or 60 Hz
Correlated Color Temperature (Nom)	6500 K	Inrush current	14 A
Luminous Efficacy (rated) (Nom)	122 lm/W	Inrush time	0.01 ms
Color rendering index (CRI)	≥80	Power Consumption	9.8 W
Number of light sources	24	Power Factor (Fraction)	0.9
Beam angle of light source	- degree(s)	Connection	Flying leads/wires
Light source color	865 cool daylight	Cable	2×0.75mm² Cable 0.2 m without plug
Optic type	Facetted reflector	Number of products on MCB of 16 A type B	204

GreenSpace G6

Temperature

Ambient temperature range	-20 to +40 °C
---------------------------	---------------

Controls and Dimming

Dimmable	No
Control interface	-

Mechanical and Housing

Housing Material	Aluminum die-cast
Reflector material	Polycarbonate
Optic material	Polycarbonate
Optical cover/lens material	Polycarbonate
Housing Color	Black and white
Mounting device	Frame for recessed mounting
Optical cover/lens finish	Matte
Overall height	80 mm
Overall diameter	162 mm

Approval and Application

Ingress protection code	IP20 [Finger-protected]
Mech. impact protection code	IK03 [0.3 J]
Protection class IEC	Safety class II
Glow-wire test	Temperature 650 °C, duration 5 s
Flammability mark	-
CE mark	CE mark
ENEC mark	-

Warranty period	3 years
Photobiological risk	Photobiological risk group 1 @200mm to EN62778
EU RoHS compliant	Yes

Initial Performance (IEC Compliant)

Luminous flux tolerance	+/-10%
Initial chromaticity	5
Power consumption tolerance	+/-10%

Application Conditions

Performance ambient temperature Tq	25 °C
Maximum dim level	Not applicable
Suitable for random switching	No

Product Data

Order product name	DN391B LED11/865 P10PSU D150 AL GMG2
Order code	911401561932
Numerator - Quantity Per Pack	1
Numerator - Packs per outer box	4
Material number (12NC)	911401561932
Full product name	DN391B LED11/865 P10PSU D150 AL GMG2



Dimensional drawing

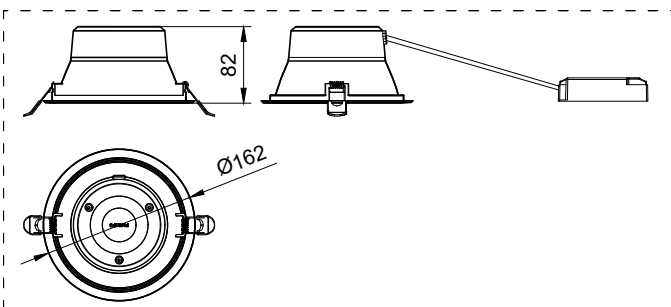

GreenSpace G6

