



GreenSpace G6

DN392B LED17/840 P14PSU D150 AL GMG2

36, 14.4 W, Facetted reflector, Polycarbonate Diffuser, 60°

Philips GreenSpace G6 builds on the GreenSpace family's reputation for superb performance, extremely low energy use, and high visual comfort. This next generation of reliable LED downlights comes in a highly-compact design with a deep, recessed architecture and increased reflector depth to highlight the smallest of details. GreenSpace G6 is also a shining example of versatility. This energy-saving LED downlight is available in a comprehensive range of configurations from 600 to 3,550 lumen, with the option to choose fixed, dimmable, or Interact Ready variants. This makes GreenSpace G6 the perfect 'mix and match' solution for potentially broad and extended applications that require different lighting ambiances, with one cohesive luminaire look and feel.

Product data

General Information		Optical cover/lens type	
Driver included	Yes	Polycarbonate Diffuser	
Gear	-	Luminaire light beam spread	
Number of gear units	-	60°	
Light source engine type	LED	Operating and Electrical	
Light Technical		Input Voltage	220 to 240 V
Luminous Flux	1,700 lumen	Line Frequency	50 or 60 Hz
Correlated Color Temperature (Nom)	4000 K	Input Frequency	50 or 60 Hz
Luminous Efficacy (rated) (Nom)	118 lm/W	Inrush current	10 A
Color rendering index (CRI)	≥80	Inrush time	0.02 ms
Number of light sources	36	Power Consumption	14.4 W
Beam angle of light source	- degree(s)	Power Factor (Fraction)	0.9
Light source color	840 neutral white	Connection	Flying leads/wires
Optic type	Facetted reflector	Cable	2×0.75mm ² Cable 0.2 m without plug
		Number of products on MCB of 16 A type B	170

GreenSpace G6

Temperature

Ambient temperature range	-20 to +40 °C
---------------------------	---------------

Controls and Dimming

Dimmable	No
Control interface	-

Mechanical and Housing

Housing Material	Aluminum die-cast
Reflector material	Polycarbonate
Optic material	Polycarbonate
Optical cover/lens material	Polycarbonate
Housing Color	Black and white
Mounting device	Frame for recessed mounting
Optical cover/lens finish	Matte
Overall height	80 mm
Overall diameter	162 mm

Approval and Application

Ingress protection code	IP20 [Finger-protected]
Mech. impact protection code	IK03 [0.3 J]
Protection class IEC	Safety class II
Glow-wire test	Temperature 650 °C, duration 5 s
Flammability mark	-
CE mark	CE mark
ENEC mark	-

Warranty period	3 years
Photobiological risk	Photobiological risk group 1 @200mm to EN62778

EU RoHS compliant	Yes
-------------------	-----

Initial Performance (IEC Compliant)

Luminous flux tolerance	+/-10%
Initial chromaticity	5
Power consumption tolerance	+/-10%

Application Conditions

Performance ambient temperature Tq	25 °C
Maximum dim level	Not applicable
Suitable for random switching	No

Product Data

Order product name	DN392B LED17/840 P14PSU D150 AL GMG2
Order code	911401564232
Numerator - Quantity Per Pack	1
Numerator - Packs per outer box	4
Material number (12NC)	911401564232
Full product name	DN392B LED17/840 P14PSU D150 AL GMG2



Dimensional drawing

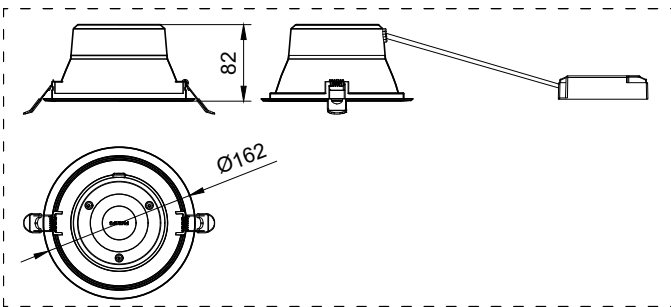

GreenSpace G6

