



GreenSpace G6

DN392B LED20/865 P17PSD D150 WH GMG2

40, 16.6 W, White reflector and opal cover, Polycarbonate Diffuser, 85°

Philips GreenSpace G6 builds on the GreenSpace family's reputation for superb performance, extremely low energy use, and high visual comfort. This next generation of reliable LED downlights comes in a highly-compact design with a deep, recessed architecture and increased reflector depth to highlight the smallest of details. GreenSpace G6 is also a shining example of versatility. This energy-saving LED downlight is available in a comprehensive range of configurations from 600 to 3,550 lumen, with the option to choose fixed, dimmable, or Interact Ready variants. This makes GreenSpace G6 the perfect 'mix and match' solution for potentially broad and extended applications that require different lighting ambiances, with one cohesive luminaire look and feel.

Product data

General Information	
Driver included	Yes
Gear	-
Number of gear units	-
Light source engine type	LED
Light Technical	
Luminous Flux	2,000 lumen
Correlated Color Temperature (Nom)	6500 K
Luminous Efficacy (rated) (Nom)	120 lm/W
Color rendering index (CRI)	≥80
Number of light sources	40
Beam angle of light source	- degree(s)

Light source color	865 cool daylight
Optic type	White reflector and opal cover
Optical cover/lens type	Polycarbonate Diffuser
Luminaire light beam spread	85°
Operating and Electrical	
Input Voltage	220 to 240 V
Line Frequency	50 or 60 Hz
Input Frequency	50 or 60 Hz
Inrush current	5.5 A
Inrush time	0.055 ms
Power Consumption	16.6 W
Power Factor (Fraction)	0.9

GreenSpace G6

Connection	2 Push-in connector 2-pole
Cable	-
Number of products on MCB of 16 A type B 54	
Temperature	
Ambient temperature range	-20 to +40 °C
Controls and Dimming	
Dimmable	DALI
Control interface	DALI
Mechanical and Housing	
Housing Material	Aluminum die-cast
Reflector material	Polycarbonate
Optic material	Polycarbonate
Optical cover/lens material	Polycarbonate
Housing Color	Black and white
Mounting device	Frame for recessed mounting
Optical cover/lens finish	Matte
Overall height	80 mm
Overall diameter	162 mm
Approval and Application	
Ingress protection code	IP20 [Finger-protected]
Mech. impact protection code	IK03 [0.3 J]
Protection class IEC	Safety class II
Glow-wire test	Temperature 650 °C, duration 5 s
Flammability mark	-
CE mark	CE mark

ENEC mark	-
Warranty period	3 years
Photobiological risk	Photobiological risk group 1 @200mm to EN62778
EU RoHS compliant	Yes
Initial Performance (IEC Compliant)	
Luminous flux tolerance	+/-10%
Initial chromaticity	5
Power consumption tolerance	+/-10%
Application Conditions	
Performance ambient temperature Tq	25 °C
Maximum dim level	1%
Suitable for random switching	No
Product Data	
Order product name	DN392B LED20/865 P17PSD D150 WH GMG2
Order code	911401569432
Numerator - Quantity Per Pack	1
Numerator - Packs per outer box	4
Material number (12NC)	911401569432
Full product name	DN392B LED20/865 P17PSD D150 WH GMG2



Dimensional drawing

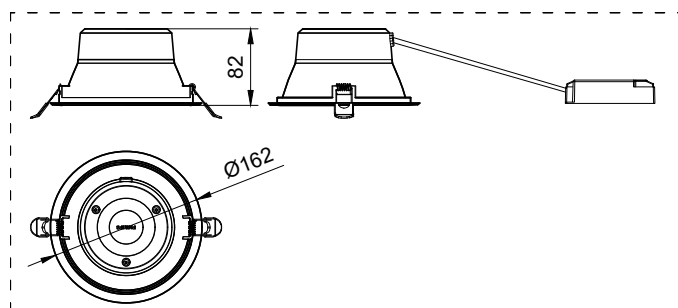

GreenSpace G6

