



# GreenSpace G6

## DN394B LED36/830 P29PSD D200 AL GMG2

78, 29.3 W, Facetted reflector, Polycarbonate Diffuser, 60°

Philips GreenSpace G6 builds on the GreenSpace family’s reputation for superb performance, extremely low energy use, and high visual comfort. This next generation of reliable LED downlights comes in a highly-compact design with a deep, recessed architecture and increased reflector depth to highlight the smallest of details. GreenSpace G6 is also a shining example of versatility. This energy-saving LED downlight is available in a comprehensive range of configurations from 600 to 3,550 lumen, with the option to choose fixed, dimmable, or Interact Ready variants. This makes GreenSpace G6 the perfect ‘mix and match’ solution for potentially broad and extended applications that require different lighting ambiances, with one cohesive luminaire look and feel.

### Product data

General Information		Optical cover/lens type	
Driver included	Yes	Optical cover/lens type	Polycarbonate Diffuser
Gear	-	Luminaire light beam spread	60°
Number of gear units	-	<b>Operating and Electrical</b>	
Light source engine type	LED	Input Voltage	220 to 240 V
<b>Light Technical</b>		Line Frequency	50 or 60 Hz
Luminous Flux	3,550 lumen	Input Frequency	50 or 60 Hz
Correlated Color Temperature (Nom)	3000 K	Inrush current	5.5 A
Luminous Efficacy (rated) (Nom)	121 lm/W	Inrush time	0.055 ms
Color rendering index (CRI)	≥80	Power Consumption	29.3 W
Number of light sources	78	Power Factor (Fraction)	0.9
Beam angle of light source	- degree(s)	Connection	2 Push-in connector 2-pole
Light source color	830 warm white	Cable	-
Optic type	Facetted reflector	Number of products on MCB of 16 A type B	54

# GreenSpace G6

## Temperature

Ambient temperature range	-20 to +40 °C
---------------------------	---------------

## Controls and Dimming

Dimmable	DALI
Control interface	DALI

## Mechanical and Housing

Housing Material	Aluminum die-cast
Reflector material	Polycarbonate
Optic material	Polycarbonate
Optical cover/lens material	Polycarbonate
Housing Color	Black and white
Mounting device	Frame for recessed mounting
Optical cover/lens finish	Matte
Overall height	107 mm
Overall diameter	216 mm

## Approval and Application

Ingress protection code	IP20 [Finger-protected]
Mech. impact protection code	IK03 [0.3 J]
Protection class IEC	Safety class II
Glow-wire test	Temperature 650 °C, duration 5 s
Flammability mark	-
CE mark	CE mark
ENEC mark	-
Warranty period	3 years

Photobiological risk	Photobiological risk group 1 @200mm to EN62778
EU RoHS compliant	Yes

## Initial Performance (IEC Compliant)

Luminous flux tolerance	+/-10%
Initial chromaticity	5
Power consumption tolerance	+/-10%

## Application Conditions

Performance ambient temperature Tq	25 °C
Maximum dim level	1%
Suitable for random switching	No

## Product Data

Order product name	DN394B LED36/830 P29PSD D200 AL GMG2
Order code	911401574332
Numerator - Quantity Per Pack	1
Numerator - Packs per outer box	4
Material number (12NC)	911401574332
Full product name	DN394B LED36/830 P29PSD D200 AL GMG2



## Dimensional drawing

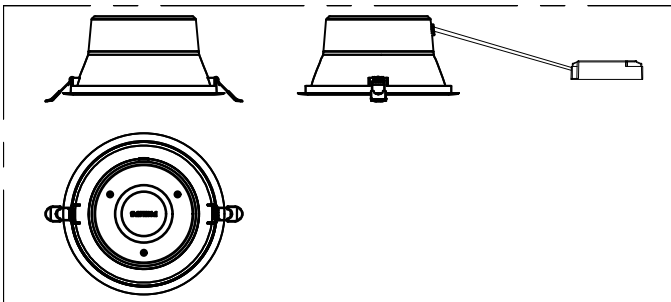

## GreenSpace G6

